

ORIGINAL PRE-FORMED PUNCH-TYPE CLAMP STAINLESS STEEL

Item Number	Part Number	Clamp Inside Dia.	Band Width	Clamps per Ctn	List Price 100 pcs per box
P110300	P-3-S	13/16"	3/8"	100	\$57.00
P110310	P-310-S	1"	3/8"	100	\$63.00
P110311	P-311-S	1-3/8"	3/8"	100	\$64.00
P110316	P-316-S	2"	3/8"	100	\$86.00
P110400	P-4-S	1"	5/8"	100	\$91.00
P110500	P-5-S	1-1/4"	5/8"	100	\$98.00
P110600	P-6-S	1-1/2"	5/8"	100	\$104.00
P110700	P-7-S	1-3/4"	5/8"	100	\$109.00
P110800	P-8-S	2"	5/8"	100	\$120.00
P110900	P-9-S	2-1/4"	5/8"	100	\$127.00
P111000	P-10-S	2-1/2"	5/8"	50	\$133.00
P111100	P-11-S	2-3/4"	5/8"	50	\$139.00
P111200	P-12-S	3"	5/8"	50	\$146.00
P111400	P-14-S	3-1/2"	5/8"	50	\$163.00
P111600	P-16-S	4"	5/8"	25	\$183.00
P111800	P-18-S	4-1/2"	5/8"	25	\$194.00
P112000	P-20-S	5"	5/8"	25	\$210.00
P112400	P-24-S	6"	5/8"	25	\$240.00
P112600	P-26-S	6-1/2"	5/8"	50	\$262.00
P112800	P-28-S	7"	5/8"	50	\$272.00
P113200	P-32-S	8"	5/8"	50	\$302.00

ORIGINAL PRE-FORMED PUNCH-TYPE CLAMP HIGH-STRENGTH GALVANIZED CARBON STEEL

Item Number	Part Number	Clamp Inside Dia.	Band Width	Clamps per Ctn	List Price 100 pcs per box
P100300	P-3	13/16"	3/8"	100	\$33.00
P100310	P-310	1"	3/8"	100	\$34.00
P100311	P-311	1-3/8"	3/8"	100	\$35.00
P100316	P-316	2"	3/8"	100	\$37.00
P100400	P-4	1"	5/8"	100	\$39.00
P100500	P-5	1-1/4"	5/8"	100	\$41.00
P100600	P-6	1-1/2"	5/8"	100	\$42.00
P100700	P-7	1-3/4"	5/8"	100	\$45.00
P100800	P-8	2"	5/8"	100	\$48.00
P100900	P-9	2-1/4"	5/8"	100	\$49.00
P101000	P-10	2-1/2"	5/8"	50	\$56.00
P101100	P-11	2-3/4"	5/8"	50	\$60.00
P101200	P-12	3"	5/8"	50	\$63.00
P101400	P-14	3-1/2"	5/8"	50	\$67.00
P101600	P-16	4"	5/8"	25	\$77.00
P101800	P-18	4-1/2"	5/8"	25	\$81.00
P102000	P-20	5"	5/8"	25	\$85.00
P102400	P-24	6"	5/8"	25	\$93.00
P102600	P-26	6-1/2"	5/8"	50	\$114.00
P102800	P-28	7"	5/8"	50	\$126.00
P103200	P-32	8"	5/8"	50	\$128.00

Double-wrapped and formed to a given diameter, ready for application

Non-spring coiled to a given diameter but not laced up through the lok.



Double-wrapped, triple locked Punch-Lok clamps hold things tightly, securely, permanently!

TO ORDER: Measure the outside diameter of the hose with its fitting inserted. Then select the next larger inside diameter clamp by catalog number. Using the hose size in inches is not sufficient information, because different thickness of hose wall result in varying outside diameters. Punch-Lok clamps are available in various materials to suit your needs. High-strength galvanized carbon steel clamps will satisfy nearly all requirements. Stainless steel clamps are for use in more corrosive situations. Evendur copper-base clamps are also available on special order.

OPEN-END PUNCH-TYPE CLAMP STAINLESS STEEL

Item Number	Part Number	Clamp Inside Dia.	Band Width	Clamps per Ctn	List Price 100 pcs per box
P140300	PO-3-S	13/16"	3/8"	100	\$146.92
P140311	PO-311-S	1-3/8"	3/8"	100	\$157.45
P140316	PO-316-S	2"	3/8"	100	\$180.18
P140325	PO-325-S	3-1/8"	3/8"	100	\$211.71
P140800	PO-8-S	2"	5/8"	100	\$218.52
P141000	PO-10-S	2-1/2"	5/8"	50	\$231.06
P141200	PO-12-S	3"	5/8"	50	\$251.46
P141400	PO-14-S	3-1/2"	5/8"	50	\$264.48
P141600	PO-16-S	4"	5/8"	50	\$291.84
P141800	PO-18-S	4-1/2"	5/8"	50	\$310.08
P142000	PO-20-S	5"	5/8"	50	\$330.60
P142400	PO-24-S	6"	5/8"	50	\$378.74
P142800	PO-28-S	7"	5/8"	25	\$447.24
P143200	PO-32-S	8"	5/8"	25	\$488.08
P143600	PO-36-S	9"	5/8"	25	\$574.38
P144000	PO-40-S	10"	5/8"	25	\$641.51
P144800	PO-48-S	12"	5/8"	25	\$737.39

OPEN-END PUNCH-TYPE CLAMP HIGH-STRENGTH GALVANIZED CARBON STEEL

Item Number	Part Number	Clamp Inside Dia.	Band Width	Clamps per Ctn	List Price 100 pcs per box
P130300	PO-3	13/16"	3/8"	100	84.54
P130311	PO-311	1-3/8"	3/8"	100	85.12
P130316	PO-316	2"	3/8"	100	86.57
P130325	PO-325	3-1/8"	3/8"	100	94.88
P130800	PO-8	2"	5/8"	100	102.00
P131000	PO-10	2-1/2"	5/8"	50	108.70
P131200	PO-12	3"	5/8"	50	122.52
P131400	PO-14	3-1/2"	5/8"	50	130.37
P131600	PO-16	4"	5/8"	50	137.35
P131800	PO-18	4-1/2"	5/8"	50	145.20
P132000	PO-20	5"	5/8"	50	152.35
P132400	PO-24	6"	5/8"	50	163.99
P132800	PO-28	7"	5/8"	25	181.87
P133200	PO-32	8"	5/8"	25	196.57
P133600	PO-36	9"	5/8"	25	212.13
P134000	PO-40	10"	5/8"	25	225.37
P134800	PO-48	12"	5/8"	25	257.38

For reduced "BULK PACK" prices contact factory. Larger size clamps are available on special order at quantities and prices subject to quotation at time of order. Contact factory, warehouse or your authorized Punch-Lok Distributor.

This page consists of clamps that are made to order and generally not stocked at any factory warehouse. These clamps are non-cancelable and not returnable.

PRE-FORMED EVERDUR CLAMPS

Item Number	Part Number	Clamp Inside Dia.	Band Width	Clamps per Ctn	List Price/100 pcs
P120400	P-4-E	1"	5/8"	100	\$332.62
P120500	P-5-E	1-1/4"	5/8"	100	\$347.45
P120600	P-6-E	1-1/2"	5/8"	100	\$373.79
P120700	P-7-E	1-3/4"	5/8"	100	\$403.44
P120800	P-8-E	2"	5/8"	100	\$441.30
P120900	P-9-E	2-1/4"	5/8"	100	\$454.48
P121000	P-10-E	2-1/2"	5/8"	50	\$484.13
P121100	P-11-E	2-3/4"	5/8"	50	\$512.13
P121200	P-12-E	3"	5/8"	50	\$566.46
P121400	P-14-E	3-1/2"	5/8"	50	\$635.62
P121600	P-16-E	4"	5/8"	25	\$685.02
P121800	P-18-E	4-1/2"	5/8"	25	\$744.29
P122000	P-20-E	5"	5/8"	25	\$849.68
P122400	P-24-E	6"	5/8"	25	\$1070.00
P122800	P-28-E	7"	5/8"	50	\$1235.00
P123200	P-32-E	8"	5/8"	50	\$1379.45

OPEN END EVERDUR CLAMPS

Item Number	Part Number	Clamp Inside Dia.	Band Width	Clamps per Ctn	List Price/100 pcs
P150700	PO-7-E	1-3/4"	5/8"	100	\$473.51
P150800	PO-8-E	2"	5/8"	100	\$475.69
P151000	PO-10-E	2-1/2"	5/8"	50	\$535.15
P151200	PO-12-E	3"	5/8"	50	\$579.76
P151400	PO-14-E	3-1/2"	5/8"	50	\$457.05
P151600	PO-16-E	4"	5/8"	50	\$728.40
P151800	PO-18-E	4-1/2"	5/8"	50	\$787.87
P152000	PO-20-E	5"	5/8"	50	\$865.92
P152400	PO-24-E	6"	5/8"	50	\$929.09



Double-wrapped, triple locked Punch-Lok clamps hold things tightly, securely, permanently!

Everdur clamps are made of a copper based material and are extremely anticorrosive, and non-magnetic. Other sizes and materials such as Monel may be produced. Consult factory for availability. Minimum quantity is one standard carton.



Non-spring coiled to a given diameter but not laced up through the lok.

MADE-TO-ORDER OPEN-END CLAMPS STAINLESS STEEL

Item Number	Part Number	Clamp Inside Dia.	Band Width	Clamps per Ctn	List Price/100 pcs
P140313	PO-313-S	1-5/8"	3/8"	100	\$241.80
P140320	PO-320-S	2-1/2"	3/8"	100	\$269.95
P140328	PO-328-S	3-1/2"	3/8"	100	\$298.07
P140332	PO-332-S	4"	3/8"	100	\$321.30
P140336	PO-336-S	4-1/2"	3/8"	100	\$344.48
P140340	PO-340-S	5"	3/8"	100	\$367.67
P140344	PO-344-S	5-1/2"	3/8"	100	\$412.38
P140348	PO-348-S	6"	3/8"	100	\$450.47
P140352	PO-352-S	6-1/2"	3/8"	100	\$485.24
P140356	PO-356-S	7"	3/8"	100	\$521.68
P140358	PO-358-S	7-1/4"	3/8"	100	\$592.90
P145600	PO-56-S	14"	5/8"	10	\$958.23
P146400	PO-64-S	16"	5/8"	10	\$1089.42
P147200	PO-72-S	18"	5/8"	10	\$1231.49
P148000	PO-80-S	20"	5/8"	10	\$1397.27
P149600	PO-96-S	24"	5/8"	10	\$2129.63
P149920	PO-120-S	30"	5/8"	10	\$2413.83
P149944	PO-144-S	36"	5/8"	10	\$2603.29
P149968	PO-168-S	42"	5/8"	10	\$2816.42
P149992	PO-192-S	48"	5/8"	10	\$3005.89

MADE-TO-ORDER OPEN-END CLAMPS HIGH-STRENGTH GALVANIZED CARBON STEEL

Item Number	Part Number	Clamp Inside Dia.	Band Width	Clamps per Ctn	List Price/100 pcs
P130313	PO-313	1-5/8"	3/8"	100	\$117.90
P130320	PO-320	2-1/2"	3/8"	100	\$127.10
P130328	PO-328	3-1/2"	3/8"	100	\$140.87
P130332	PO-332	4"	3/8"	100	\$150.06
P130336	PO-336	4-1/2"	3/8"	100	\$159.25
P130340	PO-340	5"	3/8"	100	\$174.56
P130344	PO-344	5-1/2"	3/8"	100	\$191.41
P130348	PO-348	6"	3/8"	100	\$211.31
P130352	PO-352	6-1/2"	3/8"	100	\$226.63
P130356	PO-356	7"	3/8"	100	\$248.06
P130358	PO-358	7-1/4"	3/8"	100	\$277.15
P135600	PO-56	14"	5/8"	10	\$394.15
P136400	PO-64	16"	5/8"	10	\$463.20
P137200	PO-72	18"	5/8"	10	\$542.36
P138000	PO-80	20"	5/8"	10	\$651.85
P139600	PO-96	24"	5/8"	10	\$710.80
P139920	PO-120	30"	5/8"	10	\$813.56
P139944	PO-144	36"	5/8"	10	\$963.45
P139968	PO-168	42"	5/8"	10	\$1133.59
P139992	PO-192	48"	5/8"	10	\$1248.12

TO ORDER: Measure the outside diameter of the hose with its fitting inserted. Then select the next larger inside diameter clamp by catalog number. Using the hose size in inches is not sufficient information, because different thickness of hose wall result in varying outside diameters.

PUNCH-LOK J-LOK clamps have stainless steel/buckles for added strength and corrosion resistance – with your choice of stainless steel or high-strength galvanized carbon steel bands. Totally different than punch-type clamps, **these J-LOK clamps are not for use with punch-type tools.** They are designed exclusively for application with non-punch type mechanical and air tools.

STAINLESS STEEL

Item Number	Part Number	Clamp Inside Dia.	Band Width	Clamps per Ctn	List Price/100 pcs
P470201	PJ-201	13/16"	3/8"	100	\$87.20
P470243	PJ-243	1"	3/8"	100	\$100.28
P470293	PJ-293	1"	5/8"	100	\$124.26
P470294	PJ-294	1-1/4"	5/8"	100	\$139.52
P470202	PJ-202	1-3/8"	3/8"	100	\$100.28
P470205	PJ-205	1-1/2"	5/8"	100	\$165.68
P470206	PJ-206	1-3/4"	5/8"	100	\$183.12
P470245	PJ-245	2"	3/8"	100	\$113.36
P470207	PJ-207	2"	5/8"	100	\$198.38
P470227	PJ-227	2"	3/4"	100	\$248.52
P470208	PJ-208	2-1/4"	5/8"	100	\$211.46
P470209	PJ-209	2-1/2"	5/8"	100	\$222.36
P470210	PJ-210	2-3/4"	3/4"	50	\$270.32
P470246	PJ-246	3"	3/8"	100	\$148.24
P470211	PJ-211	3"	3/4"	50	\$292.12
P470255	PJ-255	3-1/4"	3/8"	100	\$150.42
P470212	PJ-212	3-1/2"	3/4"	50	\$305.20
P470213	PJ-213	4"	3/4"	25	\$353.16
P470214	PJ-214	4-1/2"	3/4"	25	\$379.32
P470215	PJ-215	5"	3/4"	25	\$414.20
P470216	PJ-216	6"	3/4"	25	\$479.60
P470218	PJ-218	7"	3/4"	25	\$584.24
P470219	PJ-219	8"	3/4"	25	\$654.00

For reduced "BULK PACK" prices contact factory.



HIGH-STRENGTH GALVANIZED CARBON STEEL

Item Number	Part Number	Clamp Inside Dia.	Band Width	Clamps per Ctn	List Price/100 pcs
P460301	PJ-301	13/16"	3/8"	100	\$42.00
P460343	PJ-343	1"	3/8"	100	\$60.90
P460393	PJ-393	1"	5/8"	100	\$60.90
P460394	PJ-394	1-1/4"	5/8"	100	\$64.05
P460302	PJ-302	1-3/8"	3/8"	100	\$46.20
P460305	PJ-305	1-1/2"	5/8"	100	\$79.80
P460306	PJ-306	1-3/4"	5/8"	100	\$88.20
P460345	PJ-345	2"	3/8"	100	\$61.43
P460307	PJ-307	2"	5/8"	100	\$96.60
P460327	PJ-327	2"	3/4"	100	\$117.60
P460308	PJ-308	2-1/4"	5/8"	100	\$102.90
P460309	PJ-309	2-1/2"	5/8"	50	\$111.30
P460310	PJ-310	2-3/4"	3/4"	100	\$130.20
P460346	PJ-346	3"	3/8"	50	\$75.60
P460311	PJ-311	3"	3/4"	50	\$138.60
P460312	PJ-312	3-1/2"	3/4"	25	\$149.10
P460313	PJ-313	4"	3/4"	25	\$174.30
P460314	PJ-314	4-1/2"	3/4"	25	\$182.70
P460315	PJ-315	5"	3/4"	25	\$199.50
P460316	PJ-316	6"	3/4"	25	\$231.00
P460318	PJ-318	7"	3/4"	25	\$273.00
P460319	PJ-319	8"	3/4"		\$310.80

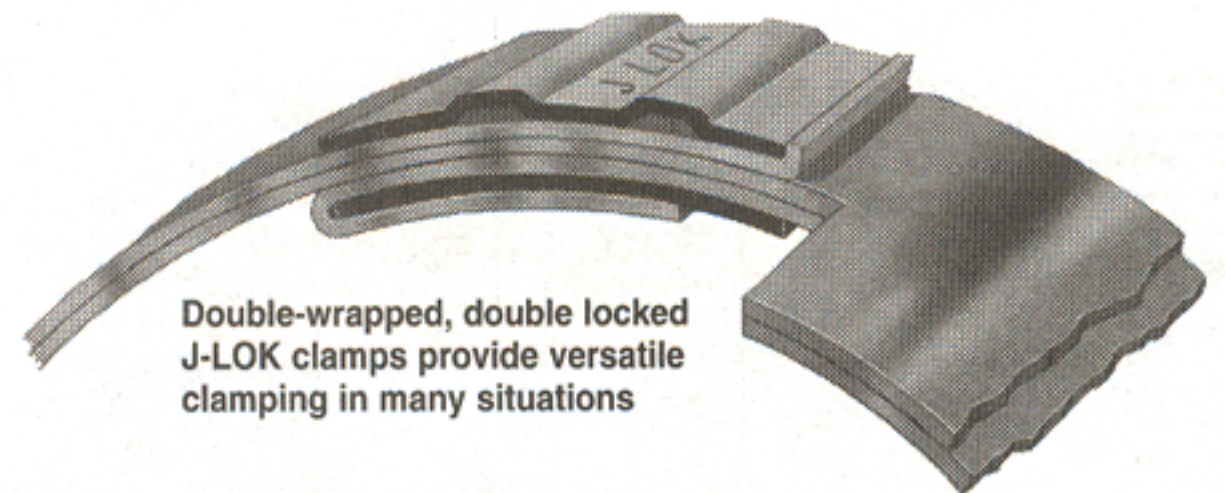

Double-wrapped, double locked J-LOK clamps provide versatile clamping in many situations

STEEL BANDING & STRAPPING 100 FEET PER ROLL (STANDARD LENGTH)

Item Number	Part Number	Description	Band Width	Band Thickness	List Price
STANDARD-DUTY 201 STAINLESS					
P811203	PB-203	Standard-duty type 201 stainless	3/8"	.025"	\$49.00
P811204	PB-204	Standard-duty type 201 stainless	1/2"	.030"	\$68.00
P811205	PB-205	Standard-duty type 201 stainless	5/8"	.030"	\$80.00
P811206	PB-206	Standard-duty type 201 stainless	3/4"	.030"	\$99.00
HEAVY-DUTY 201 STAINLESS					
P811430	PG-430	Heavy-duty type 201 stainless	3/4"	.042/.044"	\$158.00
P811431	PG-431	Heavy-duty type 201 stainless	1"	.042/.044"	\$169.00
P811432	PG-432	Heavy-duty type 201 stainless	1-1/4"	.042/.044"	\$198.00
LIGHT-DUTY 201 STAINLESS					
P800103	PC-3-S	Light-duty type 201 stainless	3/8"	.020/.023"	\$34.00
P800104	PC-4-S	Light-duty type 201 stainless	1/2"	.020/.023"	\$45.00
P800105	PC-5-S	Light-duty type 201 stainless	5/8"	.020/.023"	\$54.00
P800106	PC-6-S	Light-duty type 201 stainless	3/4"	.020/.023"	\$58.00
STANDARD 316 STAINLESS					
P811403	PC-403	Standard-duty type 316 stainless	3/8"	.025"	\$98.00
P811404	PC-404	Standard-duty type 316 stainless	1/2"	.030"	\$128.00
P811405	PC-405	Standard-duty type 316 stainless	5/8"	.030"	\$159.00
P811406	PC-406	Standard-duty type 316 stainless	3/4"	.030"	\$188.00
GALVANIZED CARBON STEEL					
P810303	PB-303	Galvanized carbon steel	3/8"	.025"	\$30.00
P810304	PB-304	Galvanized carbon steel	1/2"	.030"	\$36.00
P810305	PB-305	Galvanized carbon steel	5/8"	.030"	\$44.00
P810306	PB-306	Galvanized carbon steel	3/4"	.030"	\$56.00

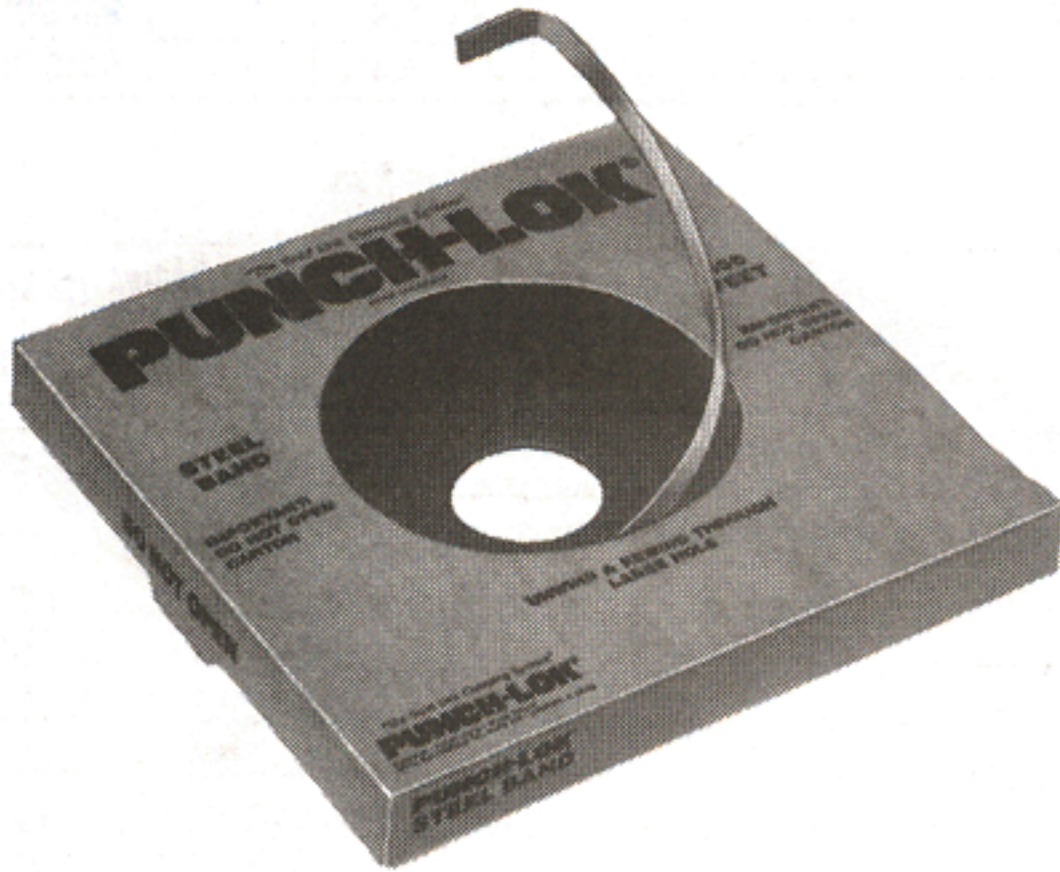

Punch-Lok Banding

Stocked in type 201 stainless steel, high-strength galvanized carbon steel, and Type 316 stainless steel. Thread band through buckle twice for greatest strength. To apply, use Punch-Lok banding tool. Model PB-001 or equivalent.

Also available in any length, mill coils, or type of steel. Call factory for prices.

SAFETY PLASTIC BOXES

Item Number	Part Number	Description	Band Width	Band Thickness	List Price
STANDARD DUTY STAINLESS SAFETY ORANGE					
P811803	PB-803	Standard duty stainless-safety yellow	3/8"	.025"	\$51.00
P811804	PB-804	Standard duty stainless-safety yellow	1/2"	.030"	\$70.00
P811805	PB-805	Standard duty stainless-safety yellow	5/8"	.030"	\$82.00
P811806	PB-806	Standard duty stainless-safety yellow	3/4"	.030"	\$101.00
HEAVY DUTY STAINLESS SAFETY ORANGE					
P811830	PG-830	Heavy duty stainless-safety orange	3/4"	.042" / .044"	\$160.00
P811831	PG-831	Heavy duty stainless-safety orange	1"	.042" / .044"	\$171.00
P811832	PG-832	Heavy duty stainless-safety orange	1-1/4"	.042" / .044"	\$200.00

Reusable corrugated plastic weather resistant packaging, ideal for rain, humidity, or moisture. Prevents the natural deterioration of cardboard.

Item Number	Part Number	Qty/Box	Description	Size	List Price / 100 pcs
STANDARD DUTY					
P831253	PB-253	100	Standard-duty buckle	3/8"	\$34.00
P831254	PB-254	100	Standard-duty buckle	1/2"	\$46.00
P831255	PB-255	100	Standard-duty buckle	5/8"	\$58.00
P831256	PB-256	100	Standard-duty buckle	3/4"	\$69.00
HEAVY DUTY					
P831440	PG-440	25	Heavy-duty buckle	3/4"	\$168.00
P831441	PG-441	25	Heavy-duty buckle	1"	\$210.00
P831442	PG-442	25	Heavy-duty buckle	1 1/4"	\$272.00
LIGHT DUTY					
P831153	PC-153	100	Light-duty clip	3/8"	\$20.00
P831154	PC-154	100	Light-duty clip	1/2"	\$28.00
P831155	PC-155	100	Light-duty clip	5/8"	\$32.00
P831156	PC-156	100	Light-duty clip	3/4"	\$39.00

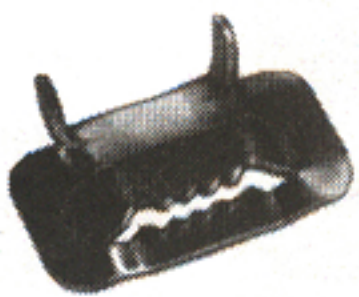

**STANDARD DUTY
BUCKLE**



**HEAVY DUTY
BUCKLE**

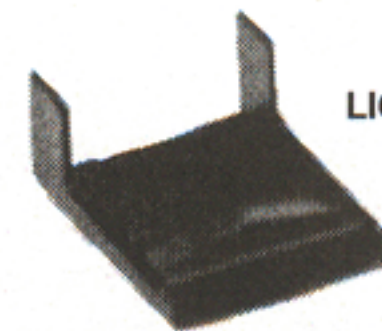

**LIGHT DUTY
CLIP**

Punch-Lok Buckles, Clips, and Loks may be used for single or double wrap banding applications. Available in high corrosion-resistant stainless steel. Also available in other types of steel.

STRAPPING LOKS STAINLESS STEEL

Item Number	Part Number	Description (100 pcs per box)	Width	List Price per 100
P820103	PL-3-S	Stainless Steel Strapping Lok	3/8"	\$36.00
P820105	PL-5-S	Stainless Steel Strapping Lok	5/8"	\$48.00

BRACKETS

Item Number	Part Number	Description (50 pcs per box)	List Price per 100
STRAIGHT LEG			
P900001	PD-001	Bracket - S.S. with S.S. Bolt & Washer	\$336.00
P900004	PD-004	Bracket - S.S. with No Bolt	\$258.00
P900011	PD-011	Bracket - Galv. w/Galv. Bolt & Washer	\$236.00
P900014	PD-014	Bracket - Galv. with No Bolt	\$196.00
FLARED LEG			
P900021	PD-021	Bracket - S.S. with S.S. Bolt & Washer	\$318.00
P900022	PD-022	Bracket - S.S. with No bolt	\$256.00
P900031	PD-031	Bracket - Galv. w/Galv. Bolt & Washer	\$236.00
P900032	PD-032	Bracket - Galv. with No bolt	\$196.00
BOLTS & WASHERS			
P900002	PD-002	S.S Bolts 3/4" x 5/16"-18NC	\$88.00
P900012	PD-012	Galv. Bolt 3/4"x5/16"-18NC	\$64.00
P900003	PD-003	Washer 3/8" i.d. 7/8" o.d.-1/16" thick	\$11.80



STRAPPING LOKS
for use with
light and standard
duty BANDING

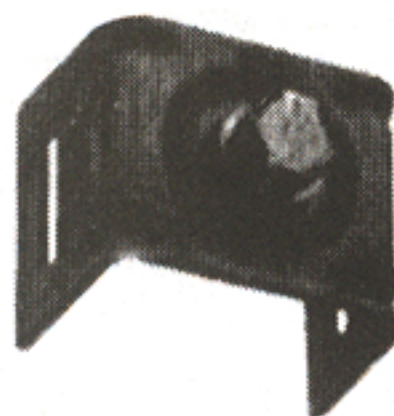

**STRAIGHT LEG
BRACKETS**

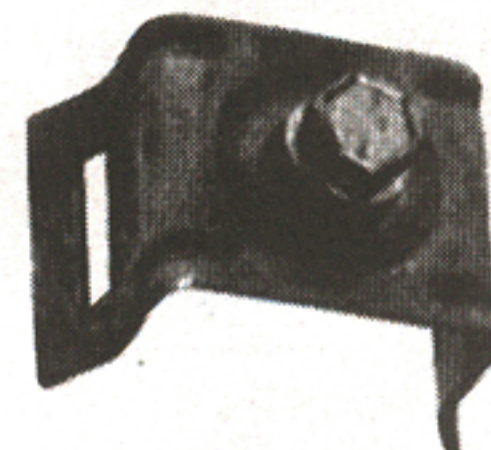

**FLARED LEG
BRACKETS**

Item Number	Part Number	Description	List Price
P200005	P-1000	Locking Tool for Punch Clamps	\$182.00
P250003	P-3000	Locking Tool for 3/8" Punch Clamps only	\$264.00
P500038	P-38	Clamp-Master Tool Set for 3/8" and 5/8" Punch Clamps	\$44.00
P250012	PB-001	Banding Tool	\$108.00
P250011	PB-001-H	H.D. Banding Tool	\$570.00
P255500	D-550	Clamp Cutter	\$127.60
P252250	D-225-A	Mallet	\$39.42

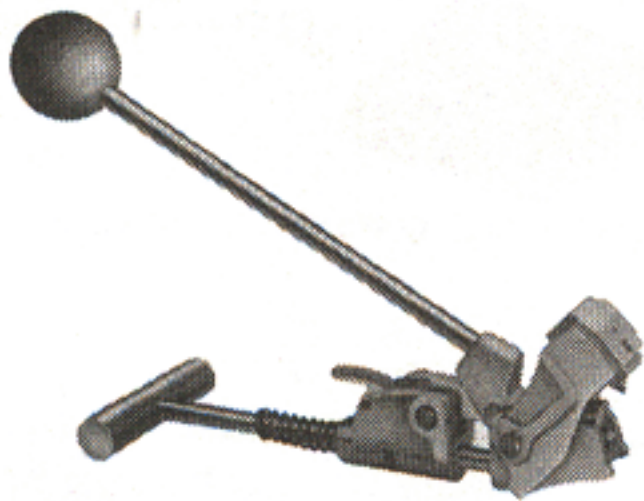

P-1000™ Loking Tool "The Punch-Lok Tool"
 The original. Made like no other tool! Designed for fast, economical application of punch-type clamps. The portable P-1000 weighs only 2 1/2 pounds. Drop forged and double plated tempered steel construction.

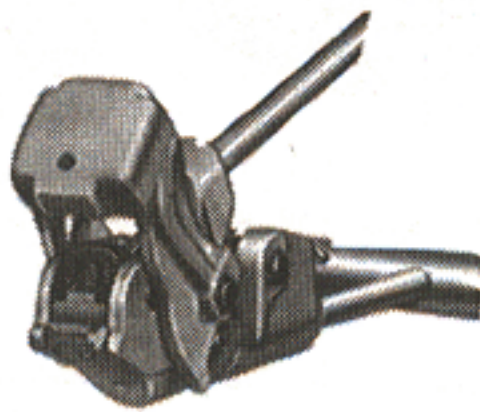

P-3000™ Loking Tool
 Similar to the Model P-1000, the Model P-3000 is for application of 3/8" wide punch-type clamps only. It will not fit 5/8" wide clamps. Double plated.



P-38™ Clamp-Master® Tool Set
 The original, handy, low cost tool set for applying punch-type clamps. Weighs less than one pound. Excellent for confined working areas and for on-job repair and replacement work. Fits 3/8" and 5/8" wide clamps. Double plated.

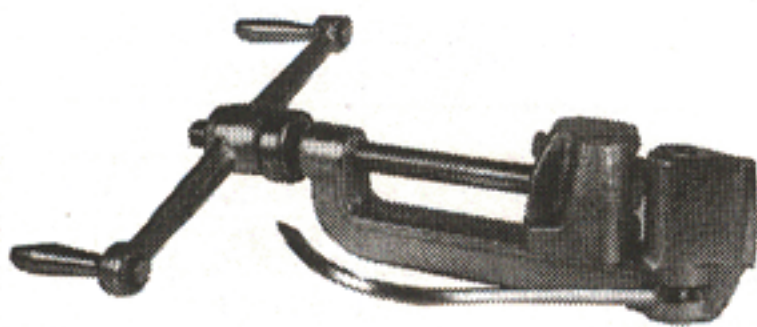

PB-001 Banding Tool
 Forged double plated tensioning tool with built-in cutter for banding and buckle application. Also can be used with PJ-001 for J-Lok Clamp installation.

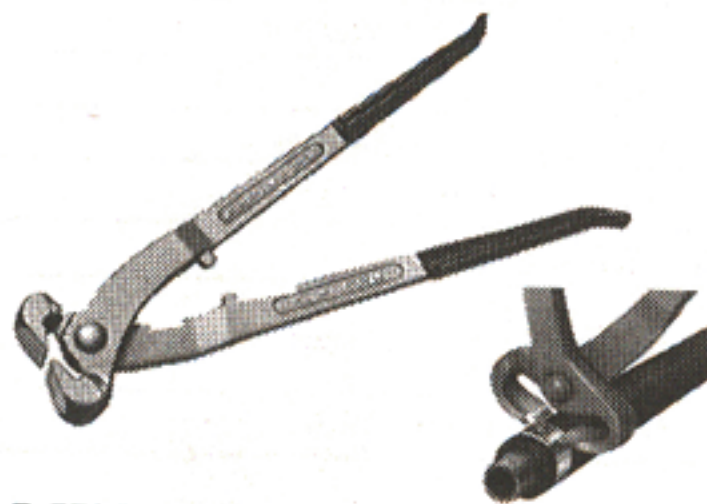

D-550™ Clamp Cutter
 Powerful 14" cutter removes any punch-type clamp with minimum effort. Rugged drop forged heat treated high-carbon steel construction. Double plated. "All New Design"



D-225-A™ Mallet
 Specially designed for the punch-locking step in applying punch-type clamps. Malleable iron head has softer striking surface for long tool life.



K-52™
Clamp-Master
kit with high-strength
galvanized carbon punch-
type steel clamps in steel case.

Item Number	Part Number	Description	List Price / ea.
P600052	K-52	Clamp-Master Kit, Galvanized Steel Clamp	\$170.00
P600152	K-52-S	Clamp-Master Kit, Stainless Steel Clamps	\$225.00
P600520	R-52	Refill Clamps (Galv.) for K-52 Kit	\$110.00
P605200	R-52-S	Refill Clamps (Stainless) for K-52-S Kit	\$159.00
P252290	D-229	3/8" Adapter for P-1000 Locking Tool	\$19.71
P250010	PJ-001	Clamp Adapter for PB-001 Tool	\$120.00
P253000	D-300-A	Bench Adapter for P-1000 and P-3000 Locking Tools	\$149.60
P700003	TA-3	Tension-Air Automatic Clamping Machine	☎



D-229™ Clamp Adapter

Fits under pusher nose of P-1 locking tool to apply 3/8" punch-type clamps.

PJ-001
Punch-Lok
J-Lok
Banding Tool
Adapter

Converts PB-001 banding tool to apply J-Lok clamps.



D-300-A™ Bench Adapter

Converts P-1000 and P-3000 locking tools to fixed bench tools to speed clamp application in tool room and hose assembly shop.

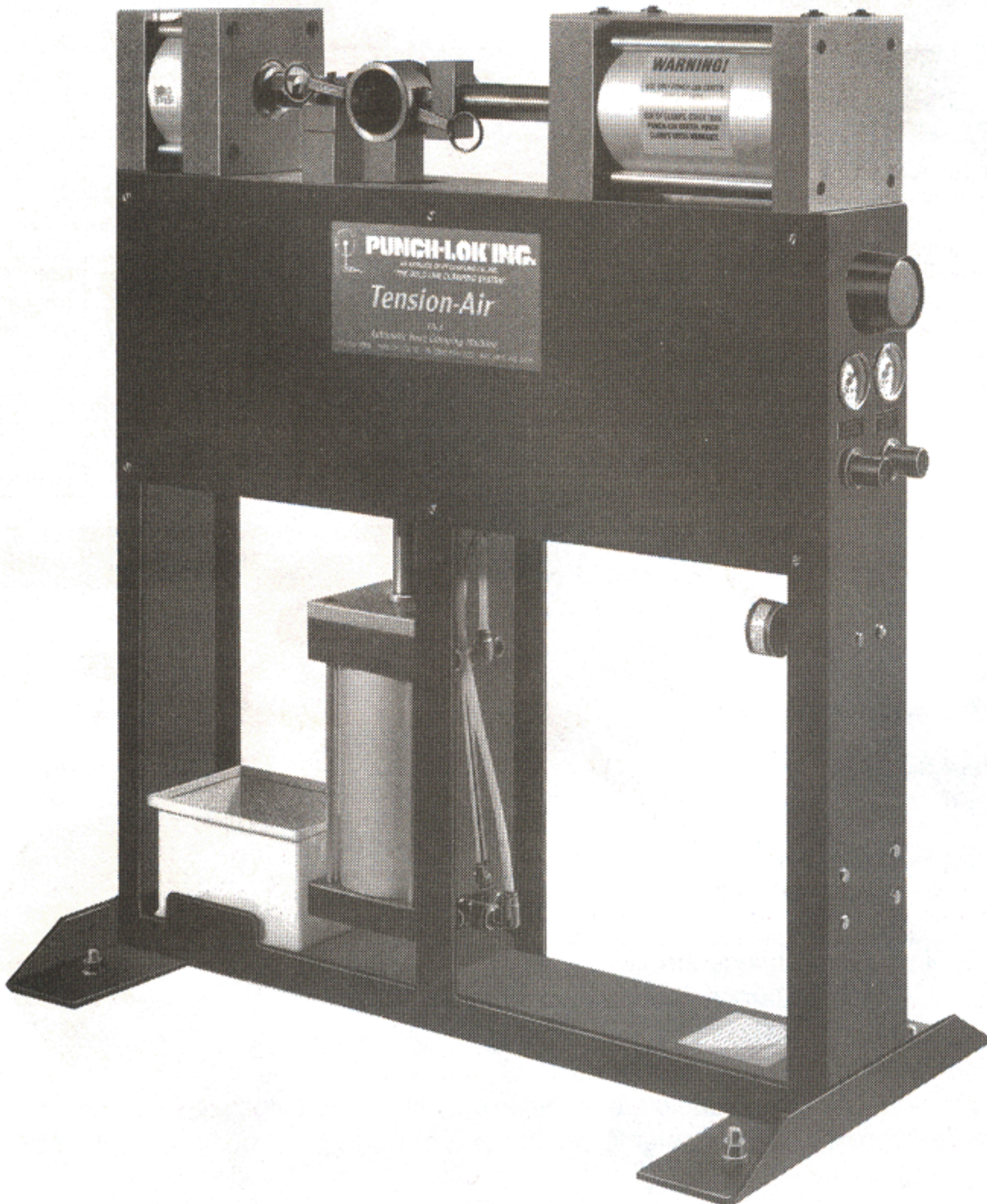
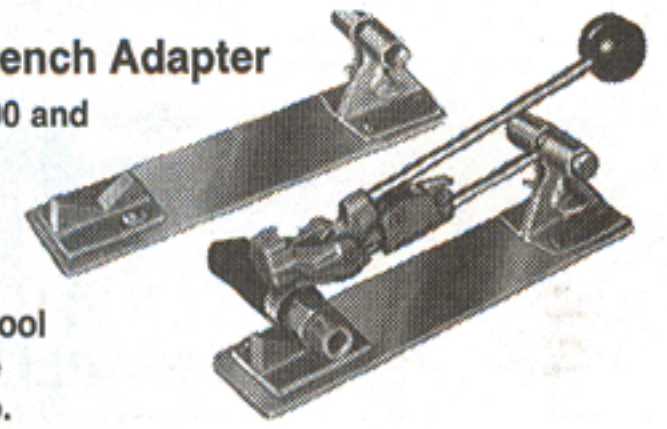

TENSION-AIR®TA-3™ Production Hose Clamping Machine

Totally automatic. No manual punching or bending required. No faster machine available for production clamping. Only requires one man & three seconds to operate.

LOK-NIPPLES™ – PLATED

Item Number	Part Number	Hose Size	Std. Pipe Thread	No. of Grooves	Qty. Per Box	Length	List Price per box
P330421	L-421	1/2"	2/4"	1	24	3-3/8"	\$78.00
P330422	L-422	1/2"	1/4"	2	24	4-5/8"	\$130.00
P330531	L-531	5/8"	3/8"	1	24	3-3/8"	\$96.00
P330532	L-532	5/8"	3/8"	2	24	4-5/8"	\$112.00
P330641	L-641	3/4"	1/2"	1	24	3-3/8"	\$70.00
P330642	L-642	3/4"	1/2"	2	24	4-5/8"	\$110.00
P330861	L-861	1"	3/4"	1	24	3-3/4"	\$110.00
P330862	L-862	1"	3/4"	2	24	5"	\$120.00
P331082	L-1082	1-1/4"	1"	2	12	5-1/2"	\$90.00
P332102	L-12102	1-1/2"	1-1/4"	2	12	5-1/2"	\$110.00
P336122	L-16122	2"	1-1/2"	2	12	6-1/4"	\$400.00

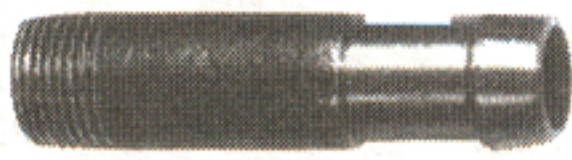

Lok-Nipple, 1 Groove

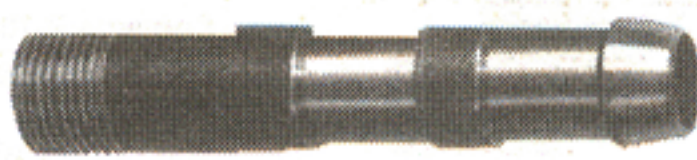

Lok-Nipple, 2 Grooves

HEX-STEEL LOK-NIPPLES™ – PLATED

Item Number	Part Number	Hose Size	Std. Pipe Thread	No. of Grooves	Length	Qty/Box	List Price/box
P300221	HX-221	1/4"	1/4"	1	2"	24	\$72.00
P300321	HX-321	3/8"	1/4"	1	2-1/2"	24	\$64.00
P300322	HX-322	3/8"	1/4"	2	3-1/2"	12	\$53.00
P300331	HX-331	3/8"	3/8"	1	2-1/2"	24	\$66.00
P300332	HX-332	3/8"	3/8"	2	3-1/2"	12	\$56.00
P300421	HX-421	1/2"	1/4"	1	2-1/2"	24	\$80.00
P300422	HX-422	1/2"	1/4"	2	3-1/2"	12	\$66.00
P300431	HX-431	1/2"	3/8"	1	2-1/2"	24	\$86.00
P300432	HX-432	1/2"	3/8"	2	3-1/2"	12	\$54.00
P300441	HX-441	1/2"	1/2"	1	2-1/2"	24	\$110.00
P300442	HX-442	1/2"	1/2"	2	3-1/2"	12	\$80.00
P300641	HX-641	3/4"	1/2"	1	3-1/8"	12	\$88.00
P300642	HX-642	3/4"	1/2"	2	4-3/8"	12	\$90.00
P300661	HX-661	3/4"	3/4"	1	3-1/8"	12	\$90.00
P300662	HX-662	3/4"	3/4"	2	4-3/8"	12	\$110.00
P300862	HX-862	1"	3/4"	2	4-3/4"	12	\$180.00
P300882	HX-882	1"	1"	2	4-3/4"	12	\$170.00
P301102	HX-10102	1-1/4"	1-1/4"	2	5"	12	\$300.00



Hex-Steel Lok-Nipple, 1 Groove

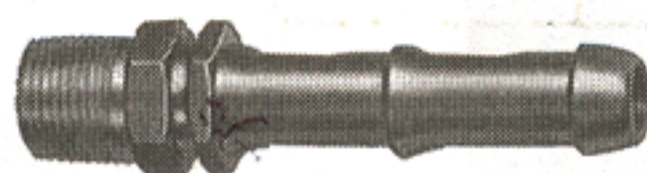

Hex-Steel Lok-Nipple, 2 Grooves

STEAM HOSE – PLATED (includes tie wires)

Item Number	Part Number	Description	NPT	Hose I.D.	Qty per Box	List Price /box
W610404	HX1212T	Standard	1/2"	1/2"	10	\$130.00
W610606	HX343T	Standard	3/4"	3/4"	10	\$180.00
W630606	XL3434T	Multi-Clamp	3/4"	3/4"	10	\$240.00
W630608	XL3410	Multi-Clamp	3/4"	1"	10	\$280.00



19.60

LOK-MENDERS™ – PLATED

Item Number	Part Number	Hose Size	No. of Grooves	Length	Qty per Box	List Price/box
P310021	BM-21	1/4"	1	2-5/8"	48	\$200.00
P310251	BM-251	5/16"	1	2-1/4"	48	\$150.00
P310031	M-31	3/8"	1	2-5/8"	24	\$91.00
P310041	M-41	1/2"	1	3-1/4"	24	\$82.00
P310042	M-42	1/2"	2	5-3/4"	24	\$104.00
P310051	M-51	5/8"	1	3-1/4"	24	\$97.00
P310052	M-52	5/8"	2	5-3/4"	24	\$110.00
P310061	M-61	3/4"	1	3-1/4"	24	\$80.00
P310062	M-62	3/4"	2	5-3/4"	24	\$140.00
P310081	M-81	1"	1	3-1/4"	24	\$80.00
P310082	M-82	1"	2	5-3/4"	24	\$120.00
P310101	M-101	1-1/4"	1	3-1/4"	12	\$50.00
P310102	M-102	1-1/4"	2	5-3/4"	12	\$86.00
P310121	M-121	1-1/2"	1	3-1/4"	12	\$60.00
P310122	M-122	1-1/2"	2	5-3/4"	12	\$90.00
P310162	M-162	2"	2	5-3/4"	12	\$160.00



Lok-Mender, 1 Groove



Lok-Mender, 2 Grooves

Punch-Lok single and double groove hose fittings of all types are designed and engineered for use with Punch-Lok Clamps to make connections which will withstand high pressure services. The shape of the grooves eliminates damage to the inner wall of the hose. The Punch-Lok Clamp brings the hose wall into the grooves with even compression around the fitting. Carbon Steel steam hose fittings are available in sizes ranging from 1/2" to 1" and include tie wires. Hex Steel Lok-Nipples are cut from hexagon shaped cold rolled steel bar stock with full thread and tapered end for easy application.

Lok-Nipples are manufactured in standard iron pipe sizes. All Lok-Menders are manufactured in standard iron pipe sizes except for 1/2" and 5/16" where it is necessary to use brass for a good inside diameter fit. All fittings are plated as standard except for brass fittings.

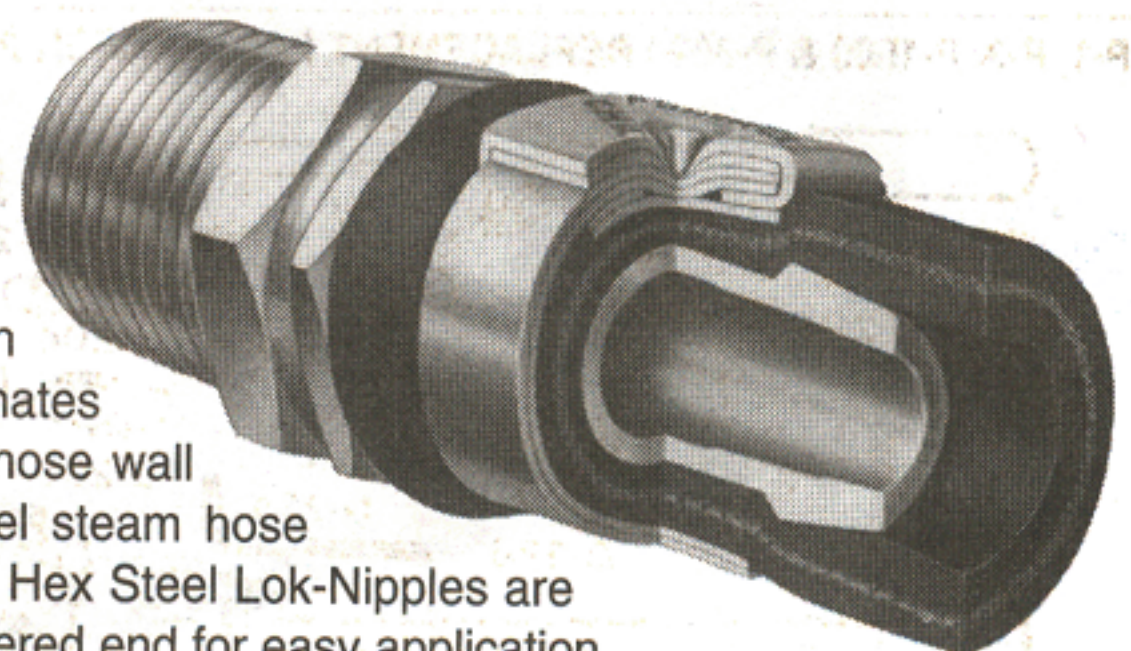

Item Number	Part Number	Description	List Price
P-1, P-3 AND P-1000 REPLACEMENT PARTS			
P252010	D-201	Punch Head	\$48.40
P252020	D-202	Punch	\$5.50
P252030	D-203	Set Screw	\$1.69
P252040	D-204	Punch Head Pin (1-7/8" long)	\$4.05
P252060	D-206	Pusher Nose	\$26.99
P252070	D-207	Holding Dog	\$28.11
P252080	D-208	Pusher Nose Pin (15//16" long)	\$5.05
P252090	D-209	Holding Dog Spring (long)	\$2.05
P252110	D-211	Puller Link (need 2)	\$16.00
P252119	D-2119	Puller Link (need 2) P-1000 Only*	\$16.00
P252120	D-212	Puller Link Pin (5/8" long)	\$6.16
P252140	D-214	Pulling Dog	\$33.52
P252149	D-2149	Pulling Dog P-1000*	\$33.52
P252150	D-215	Pulling Dog Pin (1-11/32")	\$4.73
P252160	D-216	Release Lever	\$9.26
P252169	D-2169	Release Lever P-1000*	\$9.26
P252170	D-217	Pulling Dog Spring (short)	\$2.05
P252180	D-218	Release Lever Pin	\$2.05
P252220	D-220-A	Ball Handle Assembly	\$55.56
P252224	D-224	Wrench	\$2.18
P252250	D-225A	Mallet	\$39.42
P252260	D-226	Limit Ring	\$3.03
P252280	D-228	Formed Washer	\$2.05
P252290	D-229	3/8" Clamp Adapter	\$19.71
P252310	D-231-A	Pusher-Puller Assembly (for P-1 Tool only)	\$93.25
P252311	D-231-AS	Pusher Puller Assembly (for P-3 Tool only)	\$114.30
P252420	D-242	Retaining Rings (need 4)	\$1.69
P-38 REPLACEMENT PARTS			
P252850	D-285-A	Frame	\$13.51
P252890	D-289-A	Punch and Holder	\$8.09
P252980	D-298-A	Ratchet Wrench and Winder	\$33.70
PB-001 REPLACEMENT PARTS			
P250067	PB-006	Tension Handle (Parts 7, 8, & 9)	\$36.30
P252210	PB-010	Spindle Rod	\$16.46
P252215	PB-015	Cutter Blade	\$30.80
P252216	PB-016	Ball Bearing	\$11.00
P252217	PB-017	Cutter Blade Lever	\$13.20
P252220	PB-020	Gripper	\$23.17
P252021	PB-021	Gripper Pivot Pin	\$4.40
P252022	PB-022	Cutter Blade Set Screw	\$3.30

*Note: for P-1000 Only

P-1, P-3, P-1000 & P-3000 REPLACEMENT PARTS - *FOR P-1000 ONLY

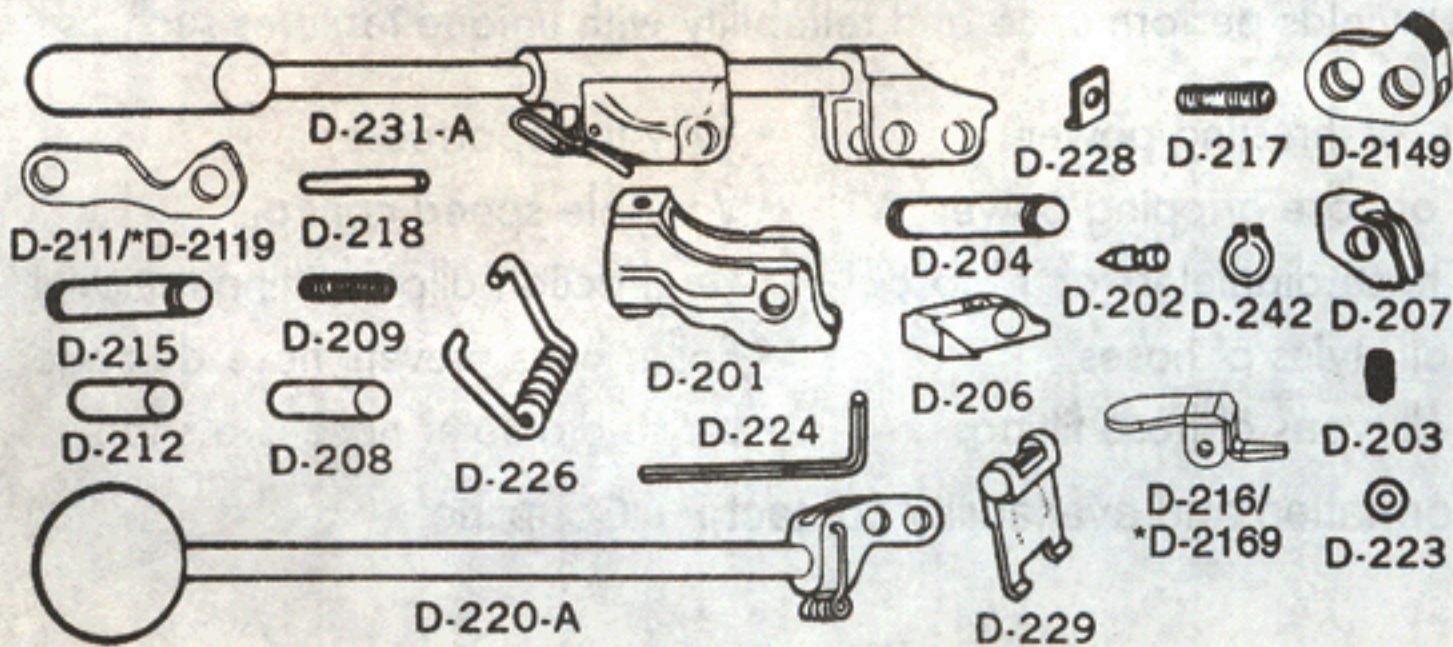

Note: The P-1000 & P-3000 Tools use the same parts as the P-1 & P-3 Tools, except for: Puller Link D-211 is D-2119 same price; Pulling Dog D-214 is D-2149 same price; Release Lever D-216 is D-2169 same price. D-226 is not used on tools dated after 1982.

P-38 REPLACEMENT PARTS

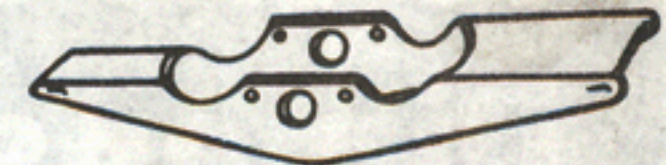

D-285-A



D-289-A

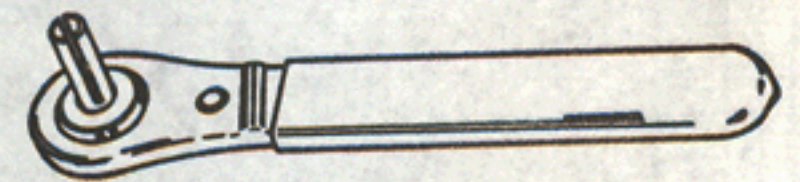

D-298-A

PB-001 REPLACEMENT PARTS

