

ST SERIES NON-VALVED INTERCHANGE COUPLINGS

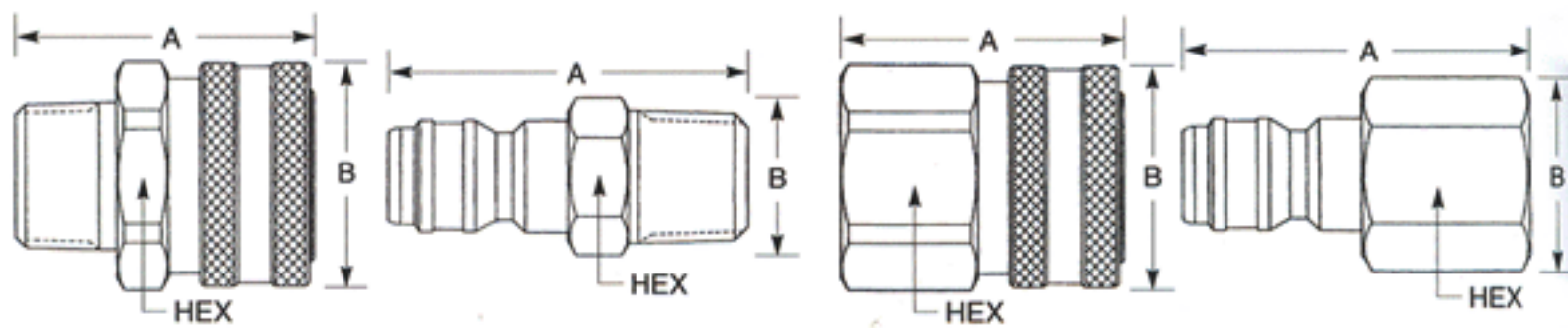

COUPLER PART NUMBER	PLUG PART NUMBER	NOMINAL SIZE	MATERIAL	THREAD F	COUPLER			PLUG		
					A	B	HEX	A	B	HEX
B-18-FC	B-18-FP	1/8"	BRASS	1/8" NPTF	1.01	.65	.56	.98	.65	.56
SS-18-FC	SS-18-FP		303 SS	1/8" NPTF	1.01	.65	.56	.98	.65	.56
B-18-MC	B-18-MP		BRASS	1/8" NPTM	1.01	.65	.56	1.15	.58	.50
SS-18-MC	SS-18-MP		303 SS	1/8" NPTM	1.01	.65	.56	1.15	.58	.50
—	18-FP		STEEL	1/8" NPTF	—	—	—	.98	.65	.56
—	18-MP		STEEL	1/8" NPTM	—	—	—	1.15	.58	.50
B-14-FC	B-14-FP	1/4"	BRASS	1/4" NPTF	1.40	.96	.81	1.47	.79	.69
SS-14-FC	SS-14-FP		303 SS	1/4" NPTF	1.40	.96	.81	1.47	.79	.69
B-14-MC	B-14-MP		BRASS	1/4" NPTM	1.66	.96	.81	1.50	.65	.56
SS-14-MC	SS-14-MP		303 SS	1/4" NPTM	1.66	.96	.81	1.50	.65	.56
—	14-FP		STEEL	1/4" NPTF	—	—	—	1.47	.79	.69
—	14-MP		STEEL	1/4" NPTM	—	—	—	1.50	.65	.56
B-38-FC	B-38-FP	3/8"	BRASS	3/8" NPTF	1.60	1.13	1.00	1.60	1.01	.88
SS-38-FC	SS-38-FP		303 SS	3/8" NPTF	1.60	1.13	1.00	1.60	1.01	.88
B-38-MC	B-38-MP		BRASS	3/8" NPTM	1.70	1.13	1.00	1.69	.79	.69
SS-38-MC	SS-38-MP		303 SS	3/8" NPTM	1.70	1.13	1.00	1.69	.79	.69
—	38-FP		STEEL	3/8" NPTF	—	—	—	1.60	1.01	.86
—	38-MP		STEEL	3/8" NPTM	—	—	—	1.69	.79	.69
B-12-FC	B-12-FP	1/2"	BRASS	1/2" NPTF	1.96	1.27	1.13	1.82	1.16	1.00
SS-12-FC	SS-12-FP		303 SS	1/2" NPTF	1.96	1.27	1.13	1.82	1.16	1.00
B-12-MC	B-12-MP		BRASS	1/2" NPTM	2.00	1.27	1.13	1.91	1.01	.88
SS-12-MC	SS-12-MP		303 SS	1/2" NPTM	2.00	1.27	1.13	1.91	1.01	.88
—	12-FP		STEEL	1/2" NPTF	—	—	—	1.82	1.16	1.00
—	12-MP		STEEL	1/2" NPTM	—	—	—	1.91	1.01	.88
B-34-FC	B-34-FP	3/4"	BRASS	3/4" NPTF	2.10	1.65	1.50	2.05	1.37	1.19
SS-34-FC	SS-34-FP		303 SS	3/4" NPTF	2.10	1.65	1.50	2.05	1.37	1.19
B-34-MC	B-34-MP		BRASS	3/4" NPTM	2.00	1.65	1.50	2.25	1.23	1.06
SS-34-MC	SS-34-MP		303 SS	3/4" NPTM	2.00	1.65	1.50	2.25	1.23	1.06
—	34-FP		STEEL	3/4" NPTF	—	—	—	2.05	1.37	1.19
—	34-MP		STEEL	3/4" NPTM	—	—	—	2.25	1.23	1.06
B-1-FC	B-1-FP	1"	BRASS	1" NPTF	2.36	2.02	1.75	2.36	1.73	1.50
SS-1-FC	SS-1-FP		303 SS	1" NPTF	2.36	2.02	1.75	2.36	1.73	1.50
B-1-MC	B-1-MP		BRASS	1" NPTM	2.61	2.02	1.75	2.45	1.59	1.38
SS-1-MC	SS-1-MP		303 SS	1" NPTM	2.61	2.02	1.75	2.45	1.59	1.38
—	1-FP		STEEL	1" NPTF	—	—	—	2.36	1.73	1.50
—	1-MP		STEEL	1" NPTM	—	—	—	2.45	1.59	1.38
B-114-FC	B-114-FP	1 1/4"	BRASS	1 1/4" NPTF	2.36	2.59	2.25	2.47	2.31	2.00
B-114-MC	B-114-MP		BRASS	1 1/4" NPTM	2.91	2.59	2.25	2.80	2.02	1.75
—	114-FP		STEEL	1 1/4" NPTF	—	—	—	2.47	2.31	2.00
—	114-MP		STEEL	1 1/4" NPTM	—	—	—	2.80	2.02	1.75
B-112-FC	B-112-FP	1 1/2"	BRASS	1 1/2" NPTF	2.89	3.18	2.75	2.74	2.60	2.25
B-112-MC	B-112-MP		BRASS	1 1/2" NPTM	3.44	3.18	2.75	3.38	2.60	2.25
—	112-FP		STEEL	1 1/2" NPTF	—	—	—	2.74	2.60	2.25
—	112-MP		STEEL	1 1/2" NPTM	—	—	—	3.38	2.60	2.25
B-2-FC	B-2-FP	2"	BRASS	2" NPTF	3.00	4.04	3.50	3.00	3.03	2.63
B-2-MC	B-2-MP		BRASS	2" NPTM	3.70	4.04	3.50	3.58	3.03	2.63
—	2-FP		STEEL	2" NPTF	—	—	—	3.00	3.03	2.63
—	2-MP		STEEL	2" NPTM	—	—	—	3.58	3.03	2.63

NOTE: ANY NOMINAL SIZE COUPLER WILL CONNECT WITH THE SAME NOMINAL SIZE PLUG REGARDLESS OF THE THREAD SIZE.
EXAMPLE: B14FC CONNECTS WITH 14-MP.

TECHNICAL DATA – ST SERIES

BODY SIZE	WORKING PRESSURE BRASS	WORKING PRESSURE STEEL	WORKING PRESSURE STAINLESS
1/8"	2,500 PSI	2,600 PSI	4,200 PSI
1/4"	4,500 PSI	5,000 PSI	6,500 PSI
3/8"	2,700 PSI	3,500 PSI	5,000 PSI
1/2"	2,500 PSI	2,700 PSI	3,000 PSI
3/4"	2,000 PSI	2,700 PSI	3,000 PSI
1"	1,000 PSI	2,000 PSI	1,500 PSI
1 1/4"	800 PSI	1,700 PSI	CF
1 1/2"	600 PSI	1,400 PSI	CF
2"	400 PSI	600 PSI	CF

CF: CONTACT FACTORY

PERFORMANCE:

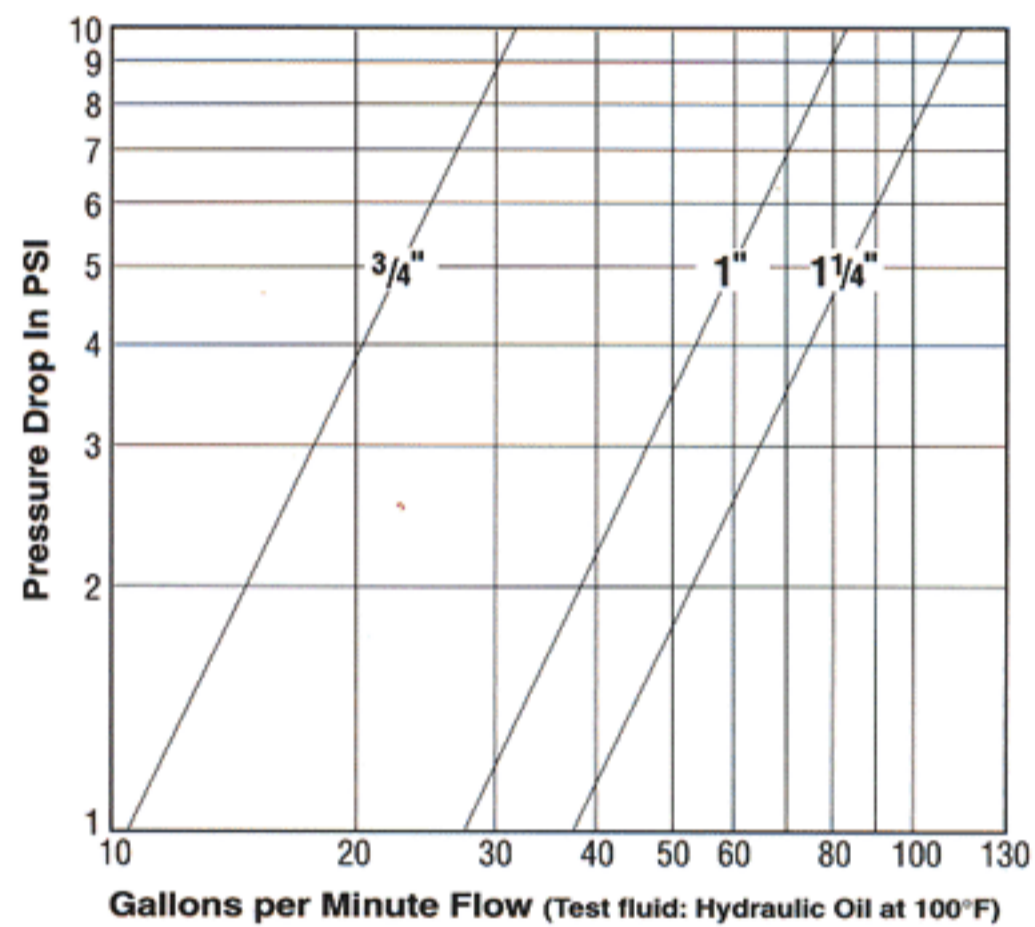
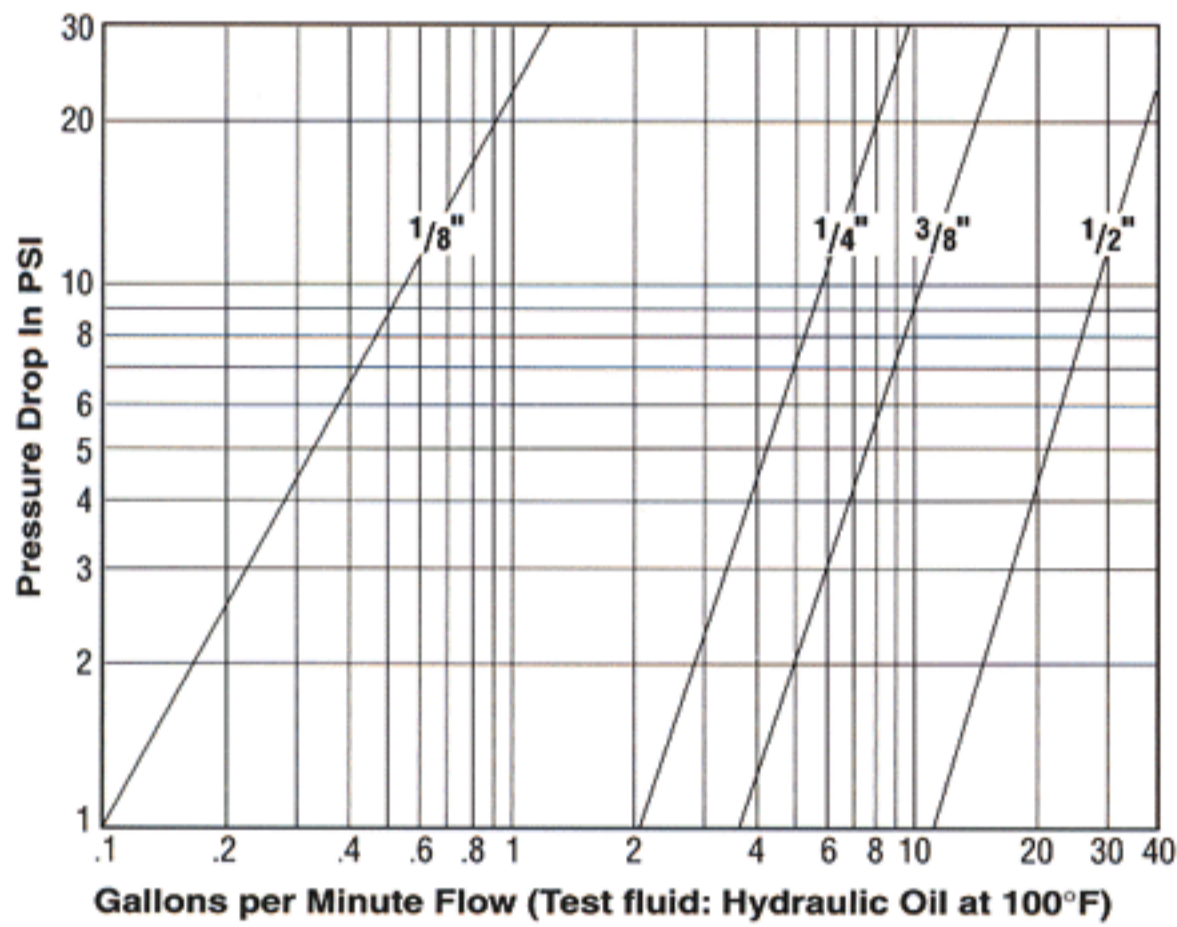

I SERIES PNEUMATIC-INDUSTRIAL INTERCHANGE COUPLINGS – MANUAL

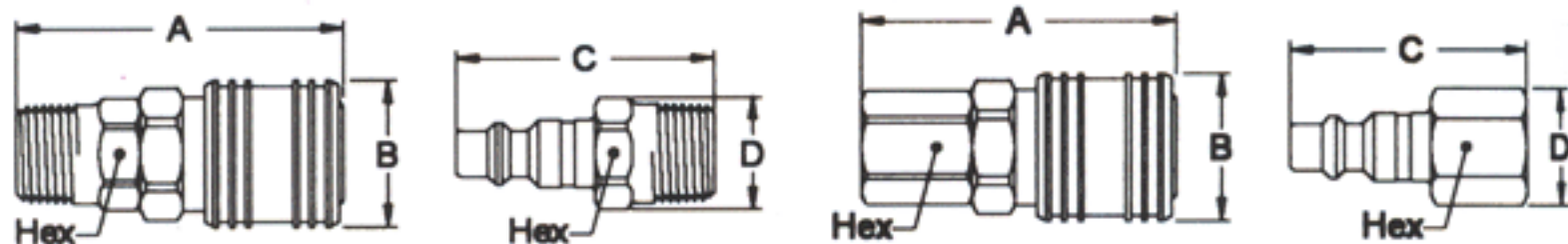

COUPLER PART NUMBER	PLUG PART NUMBER	NOMINAL SIZE	COUPLER MATERIAL	THREAD F	COUPLER			PLUG		
					A	B	HEX	C	D	HEX
I-2803-M	I-13-3		BRASS/STEEL	1/8" NPTF	1.91	1.00	.69	1.47	.65	.56
I-2903-M	I-12-3		BRASS/STEEL	1/8" NPTM	2.07	1.00	.69	1.59	.58	.50
I-3003-M	I-11-3	1/4"	BRASS/STEEL	1/4" NPTF	1.91	1.00	.69	1.63	.77	.69
C-3003M-SS	C-11-3-SS		STAINLESS	1/4" NPTF	1.91	1.00	.69	1.63	.77	.69
I-3203-M	I-15-3		BRASS/STEEL	3/8" NPTF	2.19	1.00	.75	1.63	.94	.81
C-3103M-SS	C-10-3-SS		STAINLESS	1/4" NPTF	1.91	1.00	.69	1.63	.79	.69
I-3303-M	I-14-3		BRASS/STEEL	3/8" NPTM	2.22	1.00	.69	1.75	.79	.69
I-3103-M	I-10-3		BRASS/STEEL	1/4" NPTM	2.07	1.00	.69	1.75	.65	.69
I-4004-M	I-41-4		BRASS/STEEL	1/4" NPTF	2.10	1.13	.88	1.63	.79	.69
I-4104-M	I-40-4		BRASS/STEEL	1/4" NPTM	2.35	1.13	.88	1.88	.72	.63
I-4204-M	I-43-4	3/8"	BRASS/STEEL	3/8" NPTF	2.35	1.13	.88	1.81	.94	.81
I-4304-M	I-42-4		BRASS/STEEL	3/8" NPTM	2.35	1.13	.88	1.88	.79	.69
I-4404-M	I-45-4		BRASS/STEEL	1/2" NPTF	2.62	1.13	.88	2.06	1.15	1.00
I-4504-M	I-44-4		BRASS/STEEL	1/2" NPTM	2.54	1.13	1.00	2.09	1.01	.88
I-4015-M	53-A		BRASS/STEEL	1/4" NPTF	2.72	1.19	1.10	1.92	.79	.69
I-4905-M	I-50-5		BRASS/STEEL	1/4" NPTM	2.77	1.19	1.00	2.25	.79	.69
I-5005-M	I-53-5		BRASS/STEEL	3/8" NPTF	2.78	1.19	1.10	2.06	.94	.88
I-5105-M	I-52-5	1/2"	BRASS/STEEL	3/8" NPTM	2.78	1.19	1.00	2.25	.87	.88
I-5205-M	I-55-5		BRASS/STEEL	1/2" NPTF	3.06	1.19	1.10	2.34	1.15	1.00
I-5305-M	I-54-5		BRASS/STEEL	1/2" NPTM	2.97	1.19	1.00	2.44	1.01	.88
I-5405-M	I-57-5		BRASS/STEEL	3/4" NPTF	3.09	1.19	1.19	2.44	1.37	1.19
I-5505-M	I-56-5		BRASS/STEEL	3/4" NPTM	2.97	1.19	1.06	2.50	1.23	1.06

TECHNICAL DATA

BODY SIZE	WORKING PRESSURE CONNECTED	WORKING PRESSURE DISCONNECTED	BURST PRESSURE CONNECTED	BURST PRESSURE DISCONNECTED
1/4"	1,500 PSI	500 PSI	9,000 PSI	2,000 PSI
3/8"	1,500 PSI	500 PSI	9,000 PSI	2,000 PSI
1/2"	1,500 PSI	500 PSI	9,000 PSI	2,000 PSI

NOTE: ALL PLUGS ARE STEEL UNLESS OTHERWISE NOTED.

PERFORMANCE:

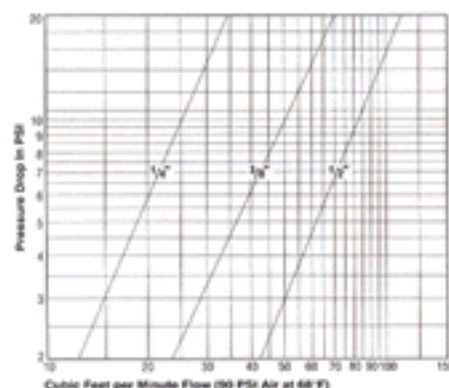

I SERIES PNEUMATIC-INDUSTRIAL INTERCHANGE COUPLINGS – AUTOMATIC

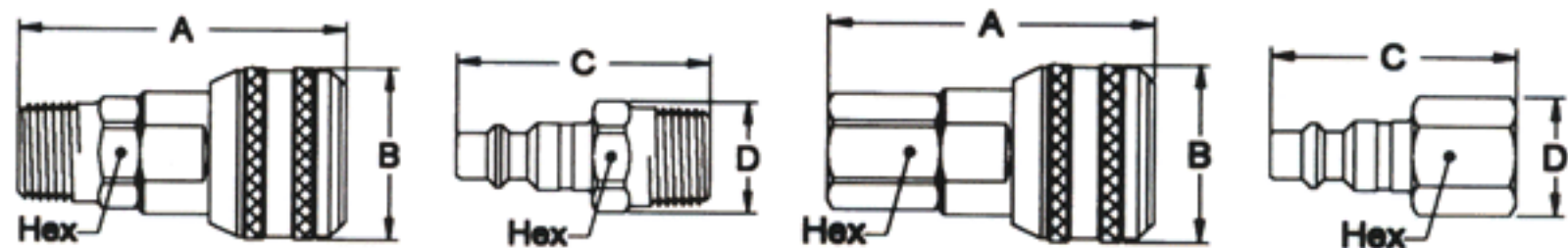

COUPLER PART NUMBER	PLUG PART NUMBER	NOMINAL SIZE	COUPLER MATERIAL	THREAD F	COUPLER			PLUG		
					A	B	HEX	C	D	HEX
I-2803-A	I-13-3	1/4"	BRASS	1/8" NPTF	1.95	1.19	.69	1.47	.65	.56
I-2903-A	I-12-3			1/8" NPTM	2.26	1.19	.69	1.59	.58	.50
I-3003-A	I-11-3			1/4" NPTF	2.17	1.19	.69	1.63	.79	.69
I-3103-A	I-10-3			1/4" NPTM	2.26	1.19	.69	1.75	.65	.56
I-3203-A	I-15-3			3/8" NPTF	2.23	1.19	.75	1.69	.94	.81
I-3303-A	I-14-3			3/8" NPTM	2.26	1.19	.69	1.75	.79	.69
I-4004-A	I-41-4	3/8"	BRASS	1/4" NPTF	2.10	1.38	.88	1.63	.79	.69
I-4104-A	I-40-4			1/4" NPTM	2.35	1.38	.88	1.88	.72	.63
I-4204-A	I-43-4			3/8" NPTF	2.35	1.38	.88	1.81	.94	.81
I-4304-A	I-42-4			3/8" NPTM	2.35	1.38	.88	1.88	.79	.69
I-4404-A	I-45-4			1/2" NPTF	2.62	1.38	1.00	2.06	1.15	1.00
I-4504-A	I-44-4			1/2" NPTM	2.54	1.38	.88	2.09	1.01	.88
I-4015-A	53-A	1/2"	BRASS	1/4" NPTF	2.72	1.50	1.00	1.92	.79	.69
I-4905-A	I-50-5			1/4" NPTM	2.78	1.50	1.00	2.25	.79	.69
I-5005-A	I-53-5			3/8" NPTF	2.79	1.50	1.00	2.06	.94	.81
I-5105-A	I-52-5			3/8" NPTM	2.79	1.50	1.00	2.25	.87	.75
I-5205-A	I-55-5			1/2" NPTF	3.07	1.50	1.00	2.34	1.15	1.00
I-5305-A	I-54-5			1/2" NPTM	2.98	1.50	1.00	2.44	1.01	.88
I-5405-A	I-57-5	3/4" NPTF	3.10	1.50	1.19	2.44	1.37	1.19		
I-5505-A	I-56-5	3/4" NPTM	2.98	1.50	1.06	2.50	1.23	1.06		
I-6206-A	I-65-6	3/4"	BRASS	1/2" NPTF	2.85	1.88	1.31	2.22	1.15	1.00
I-6306-A	I-64-6			1/2" NPTM	2.94	1.88	1.31	2.31	1.15	1.00
I-6406-A	I-67-6			3/4" NPTF	3.00	1.88	1.31	2.22	1.37	1.19
I-6506-A	I-66-6			3/4" NPTM	2.94	1.88	1.31	2.38	1.23	1.06
I-6606-A	I-69-6			1" NPTF	3.19	1.88	1.56	2.41	1.80	1.56
I-6706-A	I-68-6			1" NPTM	3.13	1.88	1.31	2.56	1.52	1.31

TECHNICAL DATA

BODY SIZE	WORKING PRESSURE CONNECTED	WORKING PRESSURE DISCONNECTED
1/4"	2000 PSI	500 PSI
3/8"	1000 PSI	500 PSI
1/2"	500 PSI	500 PSI
3/4"	220 PSI	150 PSI

PERFORMANCE:

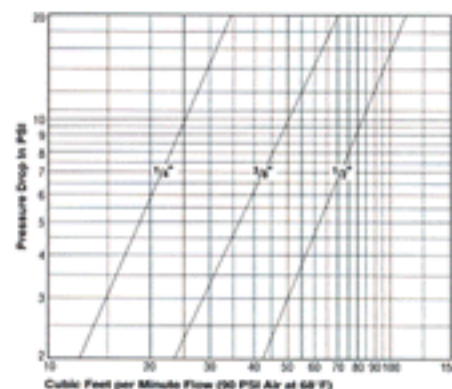

A SERIES PNEUMATIC – ARO 210/310 INTERCHANGE COUPLINGS – AUTOMATIC

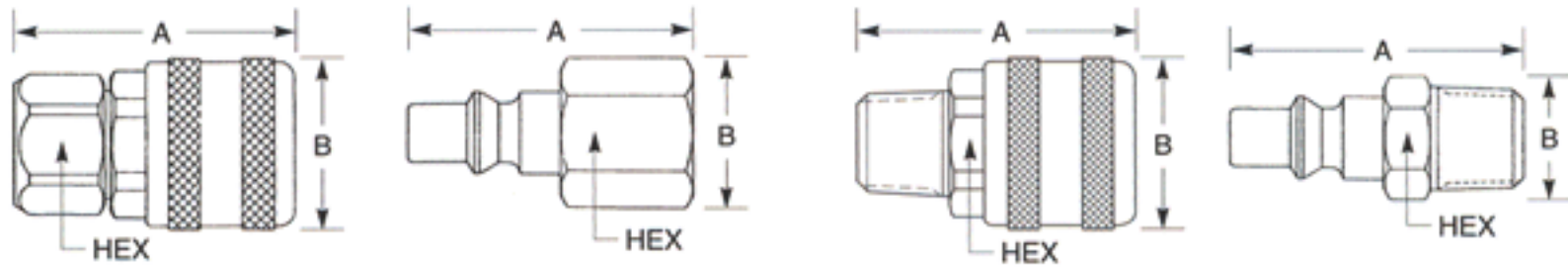

COUPLER PART NUMBER	PLUG PART NUMBER	NOMINAL SIZE	COUPLER MATERIAL	THREAD F	COUPLER			PLUG		
					A	B	HEX	A	B	HEX
A210-3003	A210-11	1/4"	STEEL	1/4" NPTF	1.65	1.01	.75	1.57	.79	.69
A210-3103	A210-10			1/4" NPTM	1.65	1.01	.75	1.48	.58	.50
A210-3303				3/8" NPTM	1.65	1.01	.75	1.60	.65	.56
A310-4204	A310-43	3/8"	BRASS	3/8" NPTF	2.11	1.20	.94	1.82	1.01	.88
A210-4303	A310-42			3/8" NPTM	2.11	1.20	.94	1.91	.79	.69

TECHNICAL DATA

BODY SIZE	WORKING PRESSURE CONNECTED	WORKING PRESSURE DISCONNECTED	BURST PRESSURE CONNECTED	BURST PRESSURE DISCONNECTED
1/4"	250 PSI	250 PSI	1,000 PSI	1,000 PSI
3/8"	250 PSI	250 PSI	1,000 PSI	1,000 PSI

PERFORMANCE:

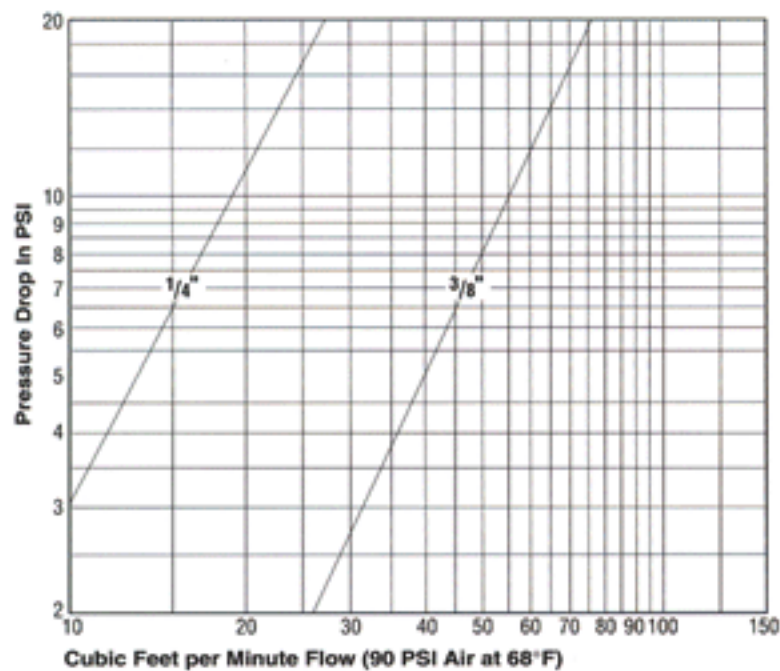

PT SERIES PNEUMATIC – PARKER® TRU-FLATE INTERCHANGE COUPLINGS/MANUAL

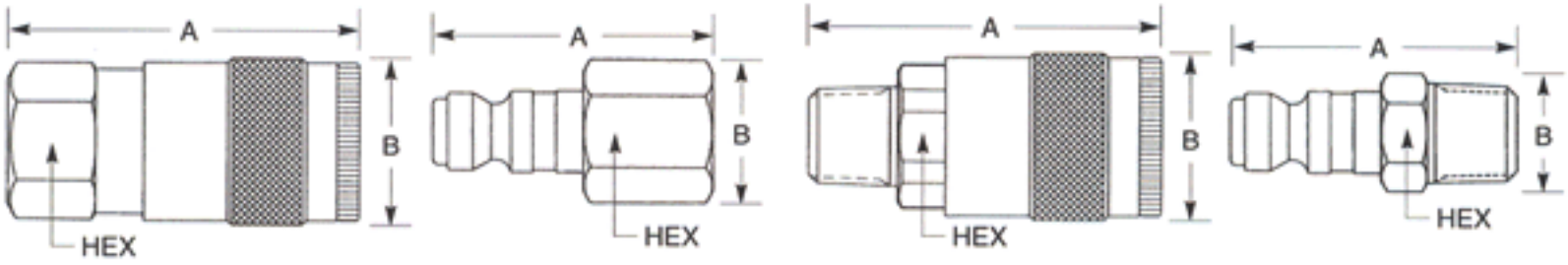

COUPLER PART NUMBER	PLUG PART NUMBER	NOMINAL SIZE	COUPLER MATERIAL	THREAD F	COUPLER			PLUG		
					A	B	HEX	A	B	HEX
PT-2803-M	PT-13	1/4"	BRASS	1/8" NPTF	1.83	.88	.75	1.34	.65	.56
PT-2903-M	PT-12			1/8" NPTM	1.88	.88	.75	1.47	.58	.50
PT-3003-M	PT-11			1/4" NPTF	2.04	.88	.75	1.56	.79	.69
PT-3103-M	PT-10			1/4" NPTM	2.04	.88	.75	1.59	.65	.56
PT-3203-M	PT-15			3/8" NPTF	2.14	.88	.81	1.56	1.01	.88
PT-3303-M	PT-14			3/8" NPTM	2.08	.88	.75	1.65	.79	.69
PT-4004-M	PT-41	3/8"	STEEL	1/4" NPTF	2.25	1.06	.88	1.75	.79	.69
PT-4104-M	PT-40			1/4" NPTM	2.45	1.06	.88	1.78	.79	.69
PT-4204-M	PT-43			3/8" NPTF	2.48	1.06	.88	1.75	1.0	.88
PT-4304-M	PT-42			3/8" NPTM	2.46	1.06	.88	1.84	.79	.69
PT-4404-M				1/2" NPTF	2.61	1.06	1.00	1.91	1.16	1.00
PT-4504-M				1/2" NPTM	2.55	1.06	.88	2.00	1.01	.88
PT-4015-M		1/2"	STEEL	1/4" NPTF	2.90	1.19	1.00	2.11	1.01	.88
PT-4905-M				1/4" NPTM	2.97	1.19	1.00	2.20	.79	.69
PT-5005-M	PT-53-5			3/8" NPTF	2.90	1.19	1.00	2.11	1.01	.88
PT-5105-M	PT-52-5			3/8" NPTM	2.97	1.19	1.00	2.20	.79	.69
PT-5205-M	PT-55-5			1/2" NPTF	3.04	1.19	1.00	2.26	1.16	1.00
PT-5305-M	PT-54-5			1/2" NPTM	3.07	1.19	1.00	2.35	1.01	.88
PT-5405-M	PT-57-5	3/4" NPTF	3.09	1.19	1.19	2.31	1.37	1.19		
PT-5505-M	PT-56-5	3/4" NPTM	3.12	1.19	1.06	2.51	1.23	1.06		

NOTE: ANY NOMINAL SIZE COUPLER WILL CONNECT WITH THE SAME NOMINAL SIZE PLUG REGARDLESS OF THE THREAD SIZE.
 EXAMPLE: PT-2803-M CONNECTS WITH PT-14.

TECHNICAL DATA

BODY SIZE	WORKING PRESSURE CONNECTED	WORKING PRESSURE DISCONNECTED	BURST PRESSURE CONNECTED	BURST PRESSURE DISCONNECTED
1/4"	1,500 PSI	500 PSI	9,000 PSI	2,000 PSI
3/8"	1,500 PSI	500 PSI	9,000 PSI	2,000 PSI
1/2"	1,500 PSI	500 PSI	9,000 PSI	2,000 PSI

PERFORMANCE:

